

ELECTRONIC
CHLOR-SCALE®
 FOR CHLORINE AND SO₂ TON CONTAINERS

<p>SAFELY MONITOR USAGE, INVENTORY AND FEED RATE</p>	<p>COMPLY WITH REGULATIONS BY DOCUMENTING USAGE</p>	<p>LOW LEVEL ALARMS PREVENT SYSTEM FROM RUNNING EMPTY</p>	<p>REMOTE MONITORING VIA 4-20mA OUTPUTS AND RS485</p>
---	--	--	--



The Electronic Chlor-Scale® is the most advanced chlorine ton container monitoring system available today. The robotically welded heavy gauge steel frame is engineered to safely handle the severe impact from tank loading and the 2-part epoxy powder coat finish protects against corrosive chlorine environments.

The pivoted scale frame design with its single electronic NTEP certi-

fied shear beam load cell keeps the amount of floor level electronics to a minimum increasing overall system reliability. Integral UHMW polyethylene roller trunnions safely cradle standard DOT 106A500X chlorine and SO₂ ton containers as well as most international 907kg and 1000kg cylinders.

Put the Chlor-Scale® to work in your plant and see why since 1967, the Chlor-Scale® has set the stan-

dard for chlorine ton container scale durability and design.

NO FINGER POINTING.
 NO FINE PRINT.™



WIZARD 4000®
 (1 TO 4 CHANNEL)
 Bulletin 400



SOLO®G2
 (1 OR 2 CHANNEL)
 Bulletin 516

The Electronic Chlor-Scale® can be used with either our Wizard 4000® advanced indicator or our Solo® G2 weight display







SPECIFICATIONS

ELECTRONIC

CHLOR - SCALE®

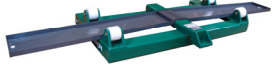
CHLORINE AND SO₂ TON CONTAINER SCALE

MODELS & ORDERING INFORMATION

MODEL (metric)	DR40 (DR20K)	DR80 (DR40K)	Accessories
NO. OF CONTAINERS	1	2 (monitors combined weight)	 <p>Drip Trays: CT-2</p>  <p>Ton Turning Bar: TCTB-1</p>  <p>Lifting Beam: LIFTBAR</p>  <p>Tank Restraints</p>  <p>Magnetic Placards: MS-5-SET</p>
CAPACITY	4000 lb (2000 kg)	8000 lb (4000 kg)	
MATERIAL	ASTM GRADE A36 Steel		
COATING	2 - Part Epoxy Powder Coat		
NO. OF ROLLERS	(4) UHMW Polyethylene	(8) UHMW Polyethylene	
OPTIONAL	(4) Bronze Bushed Steel add Model No. STL4	(8) Bronze Bushed Steel add Model No. STL8	
LOAD CELL	Single Shear Beam Strain Gauge		
CABLE LENGTH	20 ft (6 m) Standard. 30 ft (10 m), 50 ft (15 m), 100 ft (30 m) available.		
SYSTEM ACCURACY	1/4 of 1% Full Scale		
WARRANTY	5 - Year		
SHIPPING WEIGHT	200 lb (91 kg)	320 lb (145 kg)	
with STEEL ROLLERS	225 lb (102 kg)	365 lb (166 kg)	

MODEL DR40 (DR20K)
SINGLE TON CONTAINER SCALE

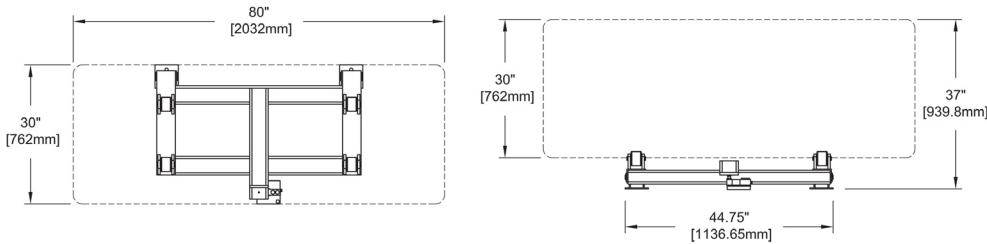

MODEL DR80 (DR40K)
DUAL TON CONTAINER SCALE

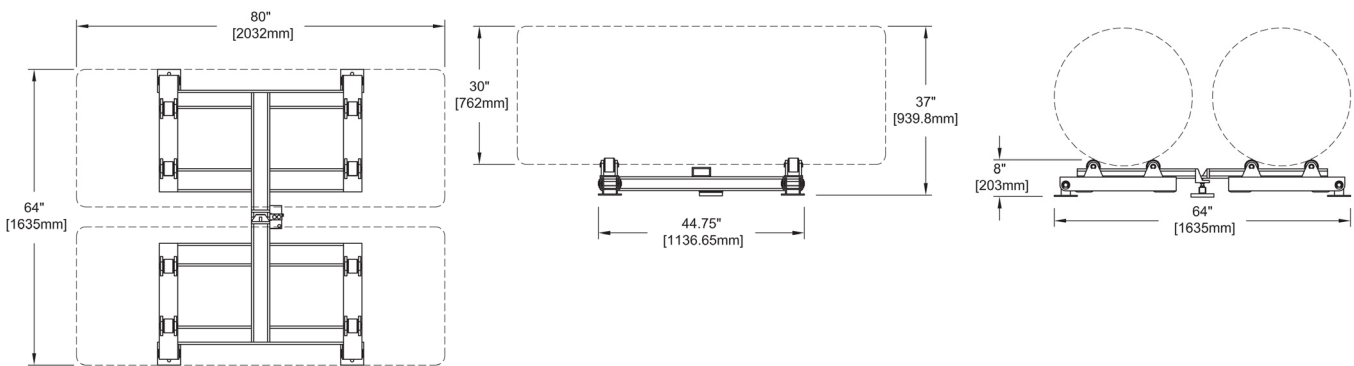

OTHER MODELS



Hydraulic Chlor-Scale®
with Century Dial® or SOLO XT®.
(Bulletin 202)

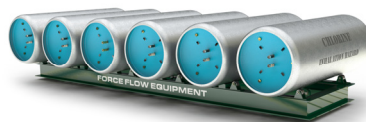

Multiple Chlor-Scale®
for monitoring banks of
3, 4, 5 and 6 containers.
(Bulletins 203 & 402)

WWW.FORCEFLOW.COM

DRAWINGS • ENGINEERED SPECS • LITERATURE

